

Crazy Iron



BMW S1000RR (K67) '18-
ID 90205212/90205217

Installing:

Left side:

Right side:

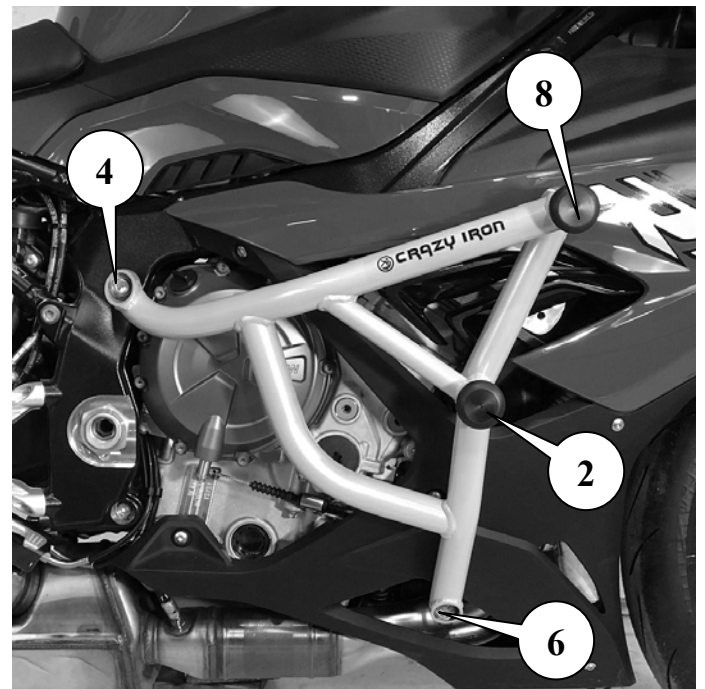
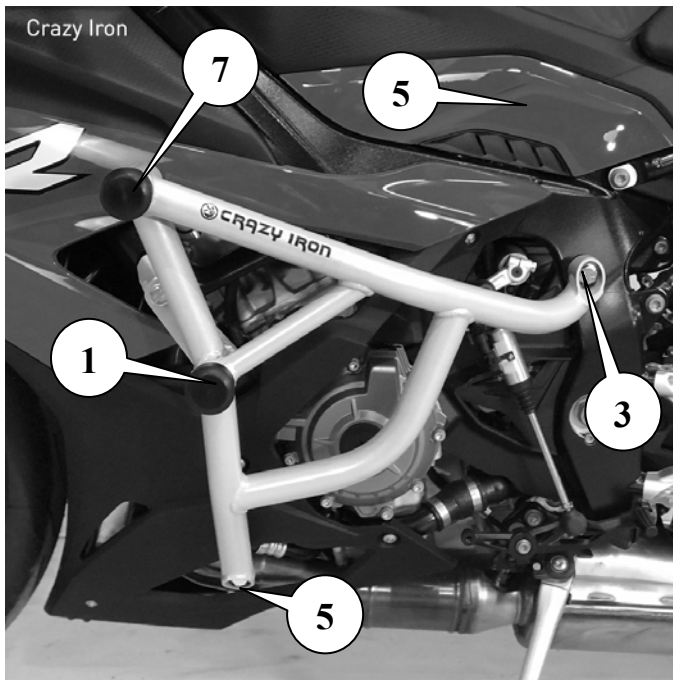



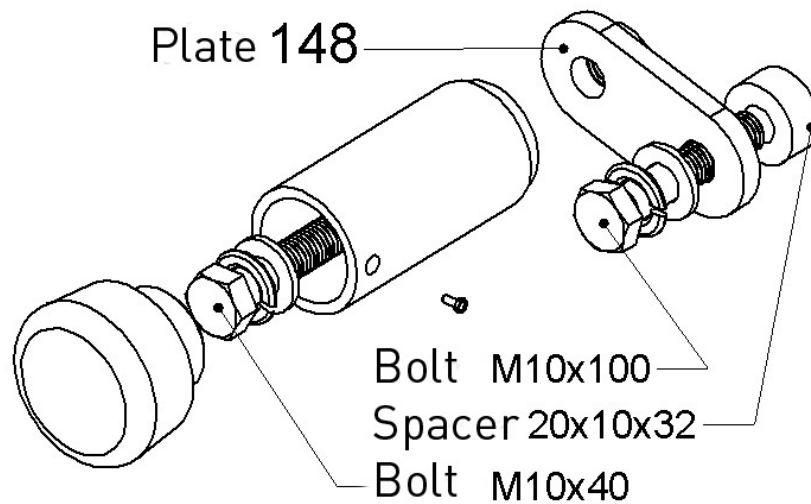





















assembly diagram at point 1



Comments:

1. Contact a specialized service, do not install the cage yourself!
2. Remove original bolts from points №1 and №3
3. Fix with bolt M10x100 through spacer 20x10x32 Plate №148. Don't tighten fasteners leave mobility of plate.
4. Attach left side of cage to points №1 and №3. Orient the plate around the bolt to align the mounting points.
5. Screw lightly with bolt M10x40 left side of cage to plate №148 in point №1 and bolt M10x100 in point №3
6. Remove original bolt in point №2
7. Attach right side of cage to points №2 and №4
8. Screw lightly with bolt M10x100 right side of cage in point №2 and with bolt M10x120 in point №4
9. Install between points №5 and №6 brace 275mm and fix with bolts M10x1,25x70
10. Затяните крепеж с усилием согласно таблице.
11. Tighten all fasteners to the torque shown in the table below.
12. Install the sliders at points No. 1,2,7,8 and fix them with screw (In case Dampper cage use damper sliders).

Tightening torques Nm		
Thread	Connection type	
	Steel	Aluminum
M6	10	6
M8	24	20
M10	48	35
M12	56	45

N	Item				
1	Bolt M10x100, Spring washer, Washer	Spacer 20x10x32	Plate 148	Bolt M10x40	Slider, Screw
					
2	Bolt M10x100	Spring washer	Washer	Slider	Screw
					
3	Bolt M10x100	Spring washer	Washer		
					
4	Bolt M10x120	Spring washer	Washer		
					
5	Bolt M10x1,25x70	Spring washer	Washer	Brace L=275	
					
6	Bolt M10x1,25x70	Spring washer	Washer		
					
7	Slider	Screw			
					
8	Slider	Screw			
	