

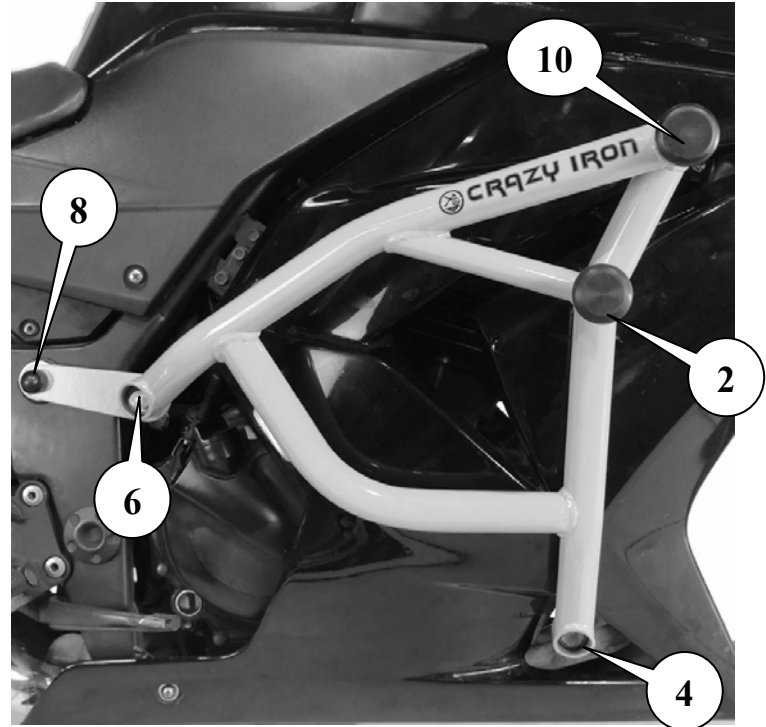

Left side:

Installing:

Right side

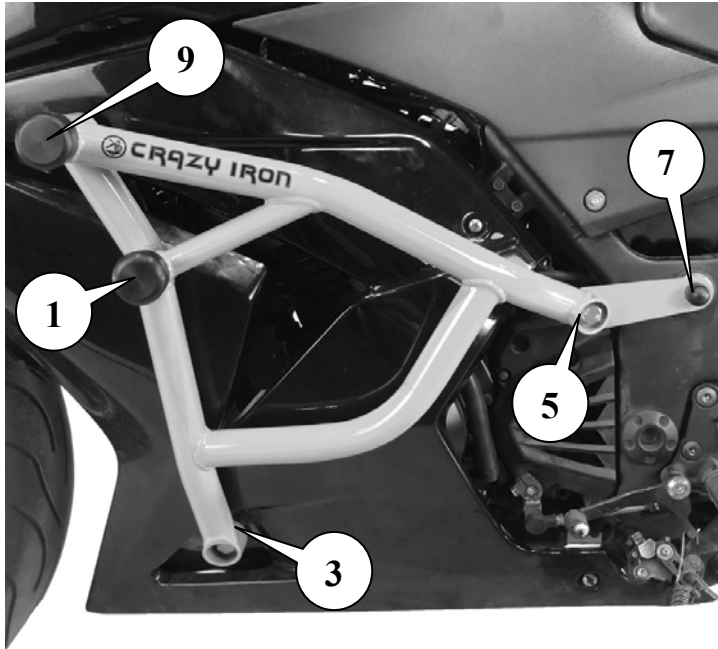

















## Comments:

1. Contact a specialized service, do not install the cage yourself!
2. Remove original fairing to see points №1 и №2
3. Remove original long bolt in point №1
4. Cut the hole in fairing with diameter 35 in points №1 and №2.
5. Install Rod M10x365 in points №1 and №2
6. Install Ear (150.01.053) in points №7 and №8. SCхему установки смотрите ниже.
7. Attach left side of cage to points №1 and №5. Screw lightly nut in point №1 and Bolt M10x1,25x40 in point №5.
8. Attach right side of cage to points №2 and №6. Screw lightly nut in point №2 and Bolt M10x1,25x40 in point №6.
9. Install brace between points №3 and №4 and screw lightly with bolts M10x1,25x30
10. Tighten the fasteners according to the table.
11. Install Sliders in points №№1,2,9,10 and fix them with screws (In case 20051017 use Damper sliders)

Tightening torques Nm		
Thread	Connection type	
	Steel	Aluminum
M6	10	6
M8	24	20
M10	48	35
M12	56	45

Component table with according numbers in the photo:

N	Imen				
1	Rod M10x365	Nut	Washer	Slider	
		Nut	Washer		
2					
3	Bolt M10x1,25x30	Spring Washer	Washer	Brace L=255 mm	
					
4		Bolt M10x1,25x30	Spring Washer		Washer
5		Spring Washer Washer		Ear 150.01.053	
					
7		Spring Washer Washer		Ear 150.01.053	Spacer sleeve 2 шт
					
6		Spring Washer Washer		Ear 150.01.053	
					
8		Spring Washer Washer		Ear 150.01.053	Spacer sleeve 2 шт
					
					

N	Item				
9	Slider	Screw			
					
10	Slider	Screw			
					
7	Decorative Cap				
					
8	Decorative Cap				
					

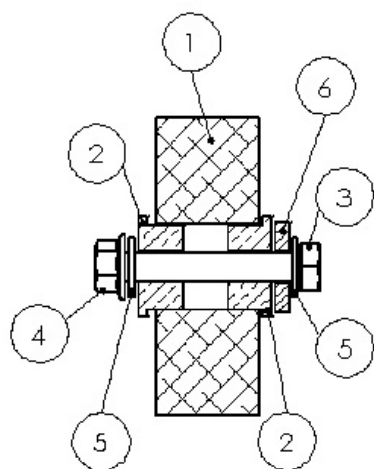

N	item	q-ty
1	motorcycle frame	1
2	spacer sleeve	2
3	Bolt M10x65	1
4	Nut M10	1
5	Washer M10	2
6	Ear 150.01.053	1

Scheme of installing mounting ear